



SPECIALIST BLASTING SYSTEMS, PAINT SPRAYING SYSTEMS AND CONVEYOR TECHNIQUE

Blasting systems

Paint spraying systems

Conveyor technique

Corrosion protection

CONTENT

From the early beginnings...	3
... until today – Company values	4
SLF International	5
Blasting	6
Blastrooms for manual or automatic blasting	7
Automatic blasting machines and manual blast cabinets	8
Media blast robot "ReCo-Blaster®"	9
Zinc spraying booths and media vacuum units	10
Blasting systems – Details	11
Painting	12
Paint spraying booths and combined paint spraying and drying booths	13
Open-space paint spraying systems	14
Open face spray booths	15
Paint dryers	16
Powder coating systems	17
Powder enamelling furnaces	18
Paint spraying systems – Details	19
Cleaning booths	20
Conveying	21
Lifting platforms	22
Conveying systems	24
Corrosion protection	25
Contract blasting services	26
Contract coating services	27
Extensive range of service	28
Maintenance and repair	29
Spare and wear parts	30
Qualification: Continuous training and education	31
Range of products and services	32

FROM THE EARLY BEGINNINGS...



The corrosion protection centre in our works in Mühlau

Welcome to SLF Oberflächentechnik GmbH

We at **SLF** have successfully been working together since 1990. Originally founded as Schlick Chemnitz Engineering GmbH, we have outgrown our original role as a vendor of blasting and coating services to become one of the leading suppliers of blasting and paint spraying systems as well as complete surface treatment centres including pre-treatment systems and conveying technique.

In our head office in Emsdetten, we design and manufacture blasting and paint spraying systems for industry sectors like rolling stock, utility vehicles and wind power plant manufacturing, machine and plant engineering, steel construction, automotive industry as well as for vendors of blasting and coating services. The conveyor technique is the connecting element. Thus the name of **SLF** stands for

Strahlen (Blasting) – **L**ackieren (Painting) – **F**ördern (Conveying)

Far beyond the local area of Saxony our works for blasting and coating services in Mühlau near Chemnitz has gained an excellent reputation as a specialized corrosion protection centre. We can always provide you with the right solution!

Vision

With our portfolio of products and services we would like to develop into a leading European medium sized manufacturer of innovative and customer individual system solutions for surface treatment technology.

Mission

We continuously develop our products further focusing on flexibility, economy and environmental compatibility of the processes of our customers. By so doing our systems reach a constant highest technical level.

With continuous trainings, education and sustainable personnel policy we retain good employees for many years thus contributing to a healthy growth of our company.

We offer individual solutions adapted to your requirements with combining pre-treatment, blasting, paint spraying and conveying technique to your related processes. We are able to build complex system plants as well as complete surface treatment centres for you.

Timeline

1990

Foundation of the company as a sales subsidiary for former Schlick Group under the name of Schlick Chemnitz Engineering GmbH

1993

Construction and opening of a centre for contract blasting and coating services in Mühlau

2000

Renaming of the company to **SLF** Oberflächentechnik GmbH, 30 employees

2003

Foundation of a branch in Western Germany: Move into the branch office in Westphalian Emsdetten

2006

Relocation in Greven-Reckenfeld, 50 employees

2008

First order from South America, 75 employees

2009

First order from China, branch office in China, first plant expansion at Mühlau site

...UNTIL TODAY – COMPANY VALUES

Timeline

2010
Market introduction of the media blast robot "ReCo-Blaster®", 20th anniversary

2012
Market introduction of "DARC®"-technology, expansion of logistics space in Greven

2013
Second plant expansion at Mühlau site, the 100th employee is hired

2014
Groundbreaking ceremony for the new headquarters in Emsdetten

2015
25th anniversary

2016
Relocation to new headquarters Emsdetten



The SLF head office in Emsdetten

Innovation

We continuously revise and develop our products, their components and our processes further for being able to offer our customers the optimal solution for their task.

Flexibility

We offer systems like e.g. our open-space paint spraying systems, telescopic drying tunnels, blast robots and blast machines that increase the flexibility of our customers' production. Also our employees are flexible in their processes in order to fulfill the requirements of our customers and partners in the most effective manner.

Partnership

Our aim is to build sustainable relationships with our customers and to develop those further to successful partnerships. The relationships with our customers do not end with commissioning of the new system, but continuously develop

further during the life cycle of the system, e.g. through after sales service. Many of our customers repeatedly place orders with us which confirms of this strategy.

Expertise

Most of our employees have long-term experiences in the field of surface treatment technology. We continuously invest in training and education of our employees to make sure that they are always up-to-date in their area of expertise and that they are able to offer excellent products and services to our customers.

Independence

As an owner-led, middle-sized company we are independent and can act with a long-term perspective and focus on a sustainable company growth. Also tomorrow and within the next years we will be your reliable and competent partner for all questions regarding surface technology.

Turnkey solutions

We are glad to work as an general contractor on a turn-key solution if this is requested by you or if it is necessary. Our specialized technical sales engineers, as well as our design team, work closely with sub-suppliers like manufacturers for conveyor or application technique to integrate their systems in the complete plant and for offering you one main contact person.

SLF INTERNATIONAL

“Our common objective is to gain and maintain the confidence of our customers by innovation, quality and reliability.”

We consider ourselves as a partner of our worldwide customers – our products and services are there to help them establish and expand their market position.

We are proud that customers from all over the world trust in the performance and efficiency of our plants. In order to take this situation into account we work together with qualified, local representatives in a growing number of coun-

tries and markets. They are able to communicate at eye level with local customers not only from a technological aspect but also regarding language and culture.

This ensures competent and direct support and advice on the spot and at all times.

Customers can rely on advanced technology. New developments like the media blast robot “ReCo-Blaster®” or the new powder enamelling furnace with “DARC®” technology as well as numerous patent and utility model applications speak for themselves.



Find more information about our sales partners on our website.

Your local support: our sales partners

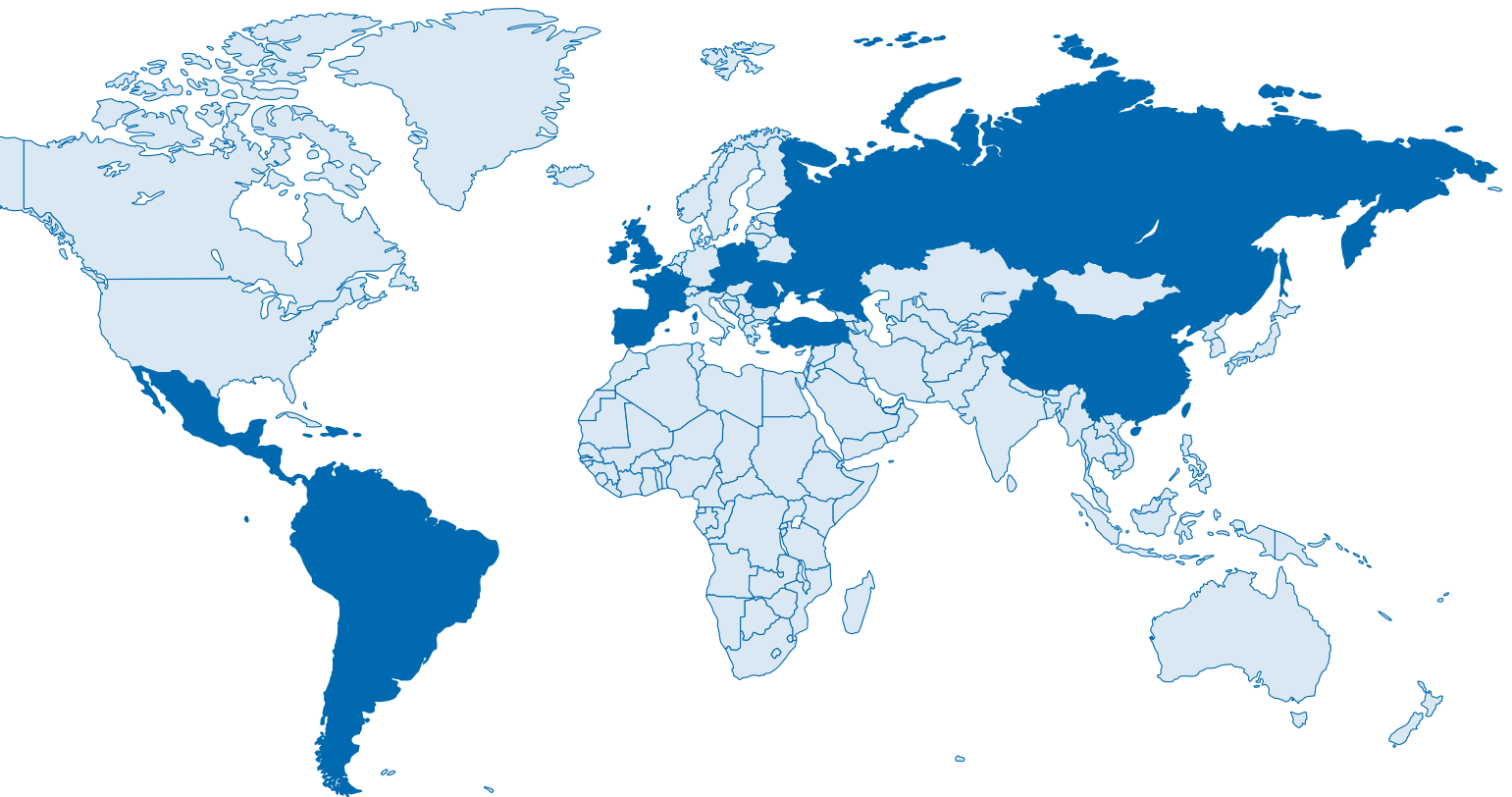

Austria | Central and South America | China | Czech Republic | France | British Isles
Poland | Portugal | Romania | Russia | Slovakia | Spain | Turkey | Ukraine

A worker in a blue protective suit and helmet is operating a blasting machine in a factory setting. The worker is kneeling on a metal grating floor, holding a long, flexible hose connected to a blasting nozzle. In the background, another worker in a yellow protective suit and helmet is standing on a yellow lifting platform, also operating a blasting machine. The environment is industrial, with various metal structures and equipment visible.

BLASTING

Blasting systems are the preferred system of choice regarding thorough and economic derusting, scale removal of steel structure, deburring, paint stripping, cleaning or shot peening of work pieces. We offer a wide range of airblast machines.

No matter if you want to blast large items like rail vehicles, wind power plant components, bridge constructions, components from machine or plant engineering industries or smaller serial parts e.g. from the automotive sector – our specialists always find the perfect solution for your process!

Our blastrooms are suitable for manual and automatic blasting by means of our media blast robot “ReCo-Blaster®” and are manufactured with mechanical abrasive transport as well as in noise-reduced and maintenance-optimized design. In addition, our blastrooms can be equipped with lifting platforms.

Our automatic blast cabinets for the treatment of smaller to larger serial parts can be delivered as blast machine with turntable, or indexing table units or as special system with or without work piece handling with robots.

BLASTROOMS FOR MANUAL OR AUTOMATIC BLASTING



Blastroom with full-floor media reclaim system and ceiling crane for components of utility vehicles

Regardless of whether you want to blast steel construction parts, wind tower segments, rail vehicles or other large components manually or automatically by means of our "ReCo-Blaster®" – we plan, manufacture and assemble your blastroom according to your requirements and operational needs.

Our blast rooms are equipped with a wear-resistant mechanical abrasive transport unit. Depending on your needs, and workflow, lamella-type conveyor floors, screw conveyors, belt conveyors, vibratory troughs or sweep hoppers can be installed for the transport of the blast media into the reconditioning unit.

In addition, we provide the appropriate conveyor technique for transporting your work pieces or the workers using lifting platforms.



Blastroom for segments and components of wind power plants

Advantages and characteristics of our blastrooms at a glance:

- maintenance-friendly concept
- manual blasting possible in robot blastrooms
- all types of abrasive deployable
- very high degree of blast media recovery and recycling and subsequently low operating costs for blast media
- wear-resistant, very bright illumination (also LED)
- **SLF** blast resistant lifting platforms
- continuous blasting due to two-chamber pressure pots
- Several workers can blast simultaneously thanks to large blast media silos.
- Blastrooms with crane slot make charging via hall crane possible.
- summer and winter mode with heated or cooled air supply

AUTOMATIC BLASTING MACHINES AND MANUAL BLASTING CABINETS

For automatic or manual blast cleaning of smaller work pieces as in e.g. the automotive industry we supply blasting machines or cabinets. Again, we design the respective system in full accordance with your individual requirements and operational needs. We supply, for example, indexing table machines with automatic nozzle guiding and work piece handling or blasting machines for rolls with automatic nozzle guiding.



Blasting station for a shot peening machine



Work piece loading and unloading by means of robot



Roller blasting systems with nozzle oscillation device in longitudinal direction of the chamber

Advantages and characteristics of our automatic blasting machines and manual blast cabinets at a glance:

- fully monitored system functions
- automatic work piece handling with very high positioning accuracy
- remotely adjustable blast pressure settings with monitoring
- all types of abrasive deployable
- automatic nozzle guiding by handling system/robot
- reproducible blast nozzle settings
- blast media dosing function with monitoring
- optimum abrasive recycling by wind sifting and screening unit
- blast media silo with level monitoring
- large maintenance openings for simple service
- customised system design
- designed as a suction or pressure blast system

MEDIA BLAST ROBOT "RECO-BLASTER®"

In order to enable effective blast cleaning of large components, especially large repetition parts, we have developed the media blast robot "ReCo-Blaster®". The "ReCo-Blaster®" is an economic alternative compared to the manual blasting process thus setting new standards for a humane and safe work station.

According to your request, the "ReCo-Blaster®" can be supplied together with a blastroom or can be integrated in your existing blastroom under certain conditions. The operation and programming is performed via a mobile control panel or an air-conditioned cabin which is installed in the blastroom and can be moved on four axes. Offline programming of the blasting process is also possible.

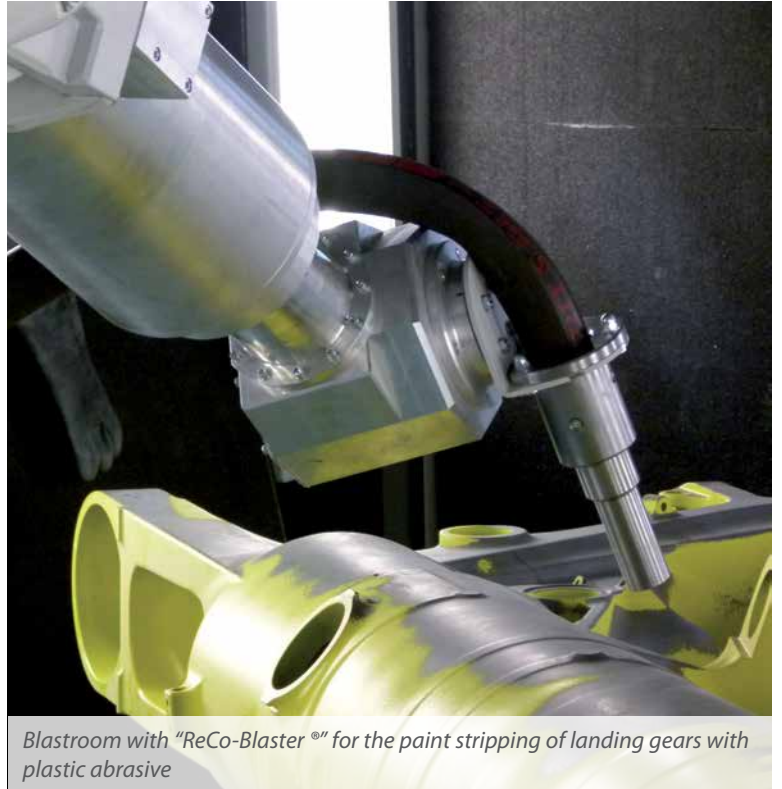

Blastroom with "ReCo-Blaster®" for the paint stripping of landing gears with plastic abrasive



Blastroom with "ReCo-Blaster®" for blasting wind power plant components

Advantages and characteristics of the "ReCo-Blaster®" at a glance:

- considerably increased surface capacity due to larger blast nozzle diameter and an increased blast pressure
- offline programming
- consistent blast quality and reproducible blasting results
- very high work and process safety
- durable and low-wear design and optimally protected against ingress of blast media
- robot movable in eight axes
- increased efficiency when blasting serial parts
- "ReCo-Blaster®" can be integrated in existing blast rooms.
- all types of abrasives deployable
- humanization of the work place
- intuitive operating system with two joysticks

ZINC SPRAYING BOOTHS AND MEDIA VACUUM UNITS

Schematic view of a dust collector with limestone powder dosing for a zinc spraying system



Zinc spraying (metallizing) is performed manually in special zinc spray booths, they consist of a zinc spray chamber, a movable suction hood for zinc overspray and a dust collector with limestone powder dosing and a CO₂ fire extinguishing unit. Such equipment for zinc spraying can also be retrofitted in existing blastrooms.

If large quantities of blast media are discharged and collect in scooping areas of the work piece, such as railcar bodies, they can be removed from the work piece and the blastroom by means of media vacuum recovery systems and can be returned into the media circuit. Depending on the application we supply different types of vacuum units for blast media recovery.

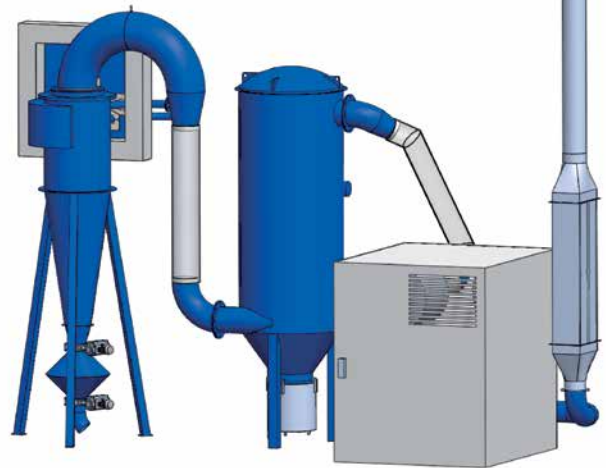

Schematic of a vacuum unit for media recovery

Advantages and characteristics of our zinc spraying rooms at a glance:

- blasting and zinc-spraying possible in one room
- retrofitting of zinc-spraying equipment into existing blastrooms possible
- turnkey solution incl. arc spraying unit
- adaption of all components like filter unit and suction hood individually to your project

Advantages and characteristics of our media vacuum units at a glance:

- quick and comfortable media recovery
- no full-floor media recovery system needed
- usable especially in large blastrooms
- various types available with different power ratings

BLASTING SYSTEMS – DETAILS

All pressure pots feature a maintenance opening which simplifies maintenance work as much as possible. Two-chamber pressure blasting pots enable continuous operations without interruption.



The use of our high-quality, sophisticatedly designed and compatible system components offers optimum circumstances regarding the flexibility, durability, low maintenance and energy balance of your blasting system.

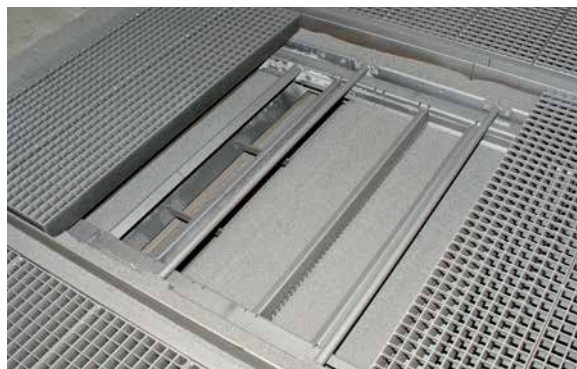

Our flat conveyor floor system allows a very high abrasive transport capacity thanks to the innovative system with its rubber lips and metal combs.

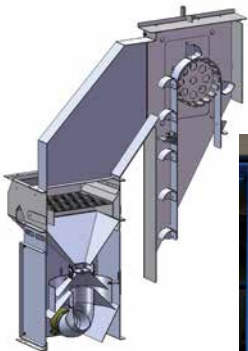

Our wind sifting unit with an upstream coarse material screening unit provides a many times higher separation surface compared to conventional wind sifting units.

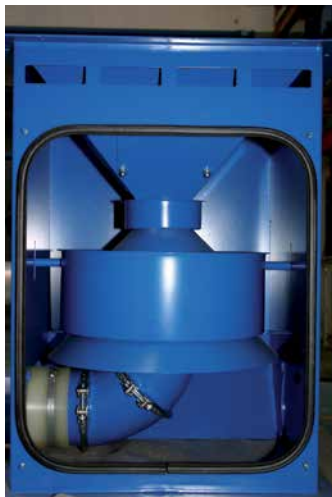

Our cartridge filter unit allows easy replacement of the cartridge filter without entering the raw gas room.



Find more information about our blasting systems on our website.

Ceiling slot for blastroom in order to integrate an overhead conveyor technique



Double magnetic separating roller for the separation of ferrous and non-ferrous blast media or material residues

The background image shows a large industrial facility. A worker wearing a dark protective suit and a white hood is standing on a yellow scissor lift. The worker is positioned next to a large, white, curved industrial component, likely a part of a turbine or engine, which is being painted. The ceiling is high and features several circular ventilation fans and bright industrial lights. The overall environment is a clean, well-lit industrial workspace.

PAINTING

Our range of products regarding paint spraying systems comprises of a large spectrum of wet paint spraying and powder coating systems including the latest innovative technology, which our engineers are constantly developing. This enables us to offer best quality systems with compelling economic efficiency, which of course correspond to the latest environmental and health and safety directives.

We plan, design and manufacture paint spraying booths, paint dryers and combined paint spraying and drying booths. Movable and telescopic dryers and booths offer highest flexibility regarding the coating and drying of large components.

One of our highlights is the open-space paint-spraying systems: It can be integrated into production halls without restricting cabin walls and offers a high degree of flexibility regarding industrial coating of work pieces.

Our paint spraying booths as well as our open-space paint spraying systems are equipped with an energy-saving sectional ventilation system by means of automatic operator detection. Fresh air and exhaust air are supplied and extracted only where needed which enables an energy saving potential of up to 70%.

PAIN T SPRAYING BOOTHS AND COMBINED PAIN T SPRAYING AND DRYING BOOTHS

With our paint spraying booths and combined paint spraying and drying booths you have the possibility to coat large work pieces in a flexible, cost-effective and high-quality manner.

Our paint spraying booths are used primarily in these industries: rolling stock and utility vehicles, wind power plants, steel construction and machine and plant engineering.

Our systems are compelling due to their charac-

teristics that make your paint spraying process more efficient and flexible. With our combined paint spraying and drying booths your work pieces can be coated and then dried in the same spot. If you need even more flexibility in your process, we can design your paint spraying booth as a movable and telescopic type.

Hence, the realized saving of space and increased flexibility are unique.



Combined paint spraying and drying booth for tramways and buses



Combined paint spraying and drying booth for rail vehicles

Advantages and characteristics of our combined paint spraying and drying booths at a glance:

- sectional air conduction leads to enormous reduction of operating costs
- low maintenance costs
- two-stage separation system – separation degree 99%
- increased filter life and extended maintenance intervals
- use of **SLF** lifting platforms is possible
- quick exchange of filter cassettes
- quick clean system as option
- high capture of harmful substance within the working area
- can be equipped with floor or side wall extraction system
- possible use of paint robots

OPEN-SPACE PAINT SPRAYING SYSTEMS



Open-space paint spraying system for steel components and steel structures



Open-space paint spraying system for components of power plants

Open-space paint spraying systems with long-range nozzles are one of our best-known systems and enable you to coat the work pieces without restricting cabin walls directly in your production hall. The flexibility of your production processes increases many times over as the charging of the paint spraying area can be performed using your hall crane or other transport methods. Furthermore, during paint spraying complex work pieces structures can be moved comfortably in the paint spraying area.

This flexibility can even be increased in combination with a movable and telescopic dryer.

Advantages and characteristics of the our open-space paint spraying systems at a glance:

- no restricting walls
- high energy saving by section ventilation system
- high capture of harmful substances within the working area
- increased flexibility and improvement of workflows
- Long range nozzle technique can be used in high halls.
- possible use of quick-clean system
- reduction of maintenance costs by two-stage separation system
- can be combined with telescopic dryers
- Paint spraying area can be used in auxiliary process times for assembly and intermediate storage.

OPEN FACE SPRAY BOOTHS

Even in companies that predominantly manufacture and treat large components small parts have to be coated from time to time. We fill this gap with our innovative open face spray booths with a dry separation system. Compared to conventional open face spray booths with simple cardboard filters the two-stage paint separation system with impact separators and secondary filter or edrizzi filter and secondary filter has many advantages. Hence, they guarantee an efficient and maintenance-friendly coating of small parts.



Open face spray booth with cardboard filters and crane slot for handling by a hall crane



Open face spray booth for the coating of attachment parts of utility vehicles

Advantages and characteristics of our open face spray booths at a glance:

- perfect for paint spraying of small parts
- two-stage paint separation system as option
- cost savings due to reduced cleaning times
- reduced maintenance costs
- single paint spraying wall or coating line incl. conveyor technique
- maintenance and cleaning during running operation
- separation degree of 99%
- quick exchange of filter cassettes
- special variants available, e.g. including crane slot

Our standard variants for open face spray booths*

Typ	Width inside (mm)	Width outside (mm)	Height inside (mm)	Height outside (mm)	Depth (mm)	Depth with porch (mm)	Extraction volume in m ³ /h	Motor power in kW	No. of paint separation cassettes
23/20	2.000	2.100	2.150	2.350	1.050	2.550	8.000	2,2	4
23/25	2.500	2.600	2.150	2.350	1.050	2.550	10.000	3	4
23/30	3.100	3.200	2.150	2.350	1.050	2.550	12.000	3	6
23/40	4.100	4.200	2.150	2.350	1.050	2.550	2 x 8.000	2 x 2,2	8

*) Special designs and equipment on request

PAINT DRYERS

For the drying process we deliver different variants of drying systems. By means of our telescopic and movable drying booths your coated work pieces can be dried in an especially efficient and space-saving way. Combined with an open-space paint spraying system this allows you to dry the coated work piece on the spot. No further transport of the work pieces is required as the dryer moves over the painted work piece.

For wet paint application we furthermore supply refrigerant dryers and circulating air dryers, while for powder coating systems we provide powder enamelling furnaces with convection or a mix of long wave infrared radiation and convection ("DARC®").



Movable and telescopic dryer with open-space paint spraying system



Drying booth for utility vehicles

Advantages and characteristics of our paint dryers at a glance:

- telescopic and/or movable design
- increase of flexibility of your production process
- drastically reduced drying times
- lower energy consumption
- reduced use of space when choosing telescopic variant
- Choosing the telescopic variant makes work piece transport superfluous.
- also applicable as adhesive water dryer
- can be designed as combined paint spraying and drying booth



Combined paint spraying and drying booth with lifting platforms

POWDER COATING SYSTEMS

Regardless of whether manual or automatic powder coating is required – we plan, design, manufacture and install your powder coating system completely including pre-treatment system, blasting system, powder enamelling furnace and conveyor technique to a custom-made solution that is perfectly integrated into your process.

Basically, the system consists of a cabin housing made of plastic, glass or steel plate, a cartridge filter unit and, if required, of a powder recuperation system with cyclone separator.

If desired we supply a turn-key powder coating system including powder application technique.



Large-volume powder coating booth for components of utility vehicles



Conveyor technique integrated in a powder coating system.

Advantages and characteristics of our powder coating systems at a glance:

- also available as large-volume powder coating booth
- can be combined with "DARC®"-powder enamelling furnace
- system concept adapted to your individual requirement
- individual pre-treatment concepts like blasting, degreasing, phosphatizing
- optimum material flow by linking of process steps
- turn-key system concept
- manual or automatic design
- integration of conveyor technique

POWDER ENAMELLING FURNACES

Besides manual and automatic powder coating systems, we also plan, design and manufacture powder enamelling furnaces and their integration in the total material flow of your system by means of conveyor technique.

Depending on the application we supply powder enamelling furnaces as conventional convection furnaces with air circulation mode or including the "DARC®" technology. The "DARC®" technology, developed by us, combines convection with long wave infrared radiation.

We implement different types of powder enamelling furnaces like, for example, chamber furnaces, continuous furnaces, furnaces with A-shaped sluices or incl. heat recovery systems as an option and extraction hoods.



"DARC®" furnace with overhead conveyor



View into a powder enamelling furnace including work piece

Advantages and characteristics of our powder enamelling furnaces at a glance:

- reduced operating costs
- increased flexibility
- reduction of work piece heating up times
- even enamelling results
- usable even on widely differing wall thicknesses
- hidden spots are also enamelled optimally
- different powder coating colours can be enamelled without mixing-up of colours
- suitable for different powder coating systems
- also usable for drying of wet paints
- also usable as an adhesive water dryer
- integration in complete plant

PAINT SPRAYING SYSTEMS – DETAILS

The use of our high-quality, sophisticatedly designed and compatible system components offers optimum circumstances regarding the flexibility, durability, low maintenance and energy balance of your paint spraying system.



The patented long-range nozzle system developed by us precisely directs heated process air from ceiling level to the operator thus reaching the proper air sinking speeds. This system is especially efficient in connection with the sectional air flow provided by our operator's detection system.



The heavy duty impact separators are the first step of our two stage paint separating system. Due to their special construction, heavy transport devices can drive on the impact separators without problems.

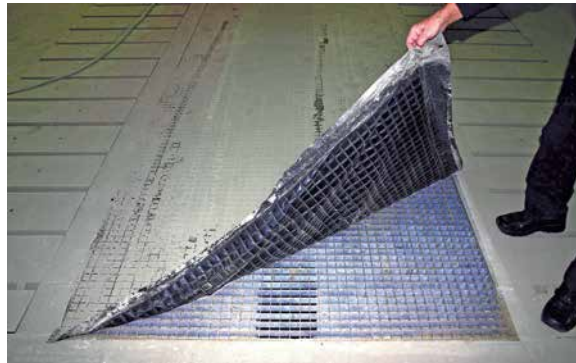

The quick clean system enables a cost-effective and quick cleaning of the paint spraying areas not covered with impact separators. The quick clean foil is drawn to the floor by means of a vacuum in the floor ducts thus adhering here even when walking over it with sticky work boots.

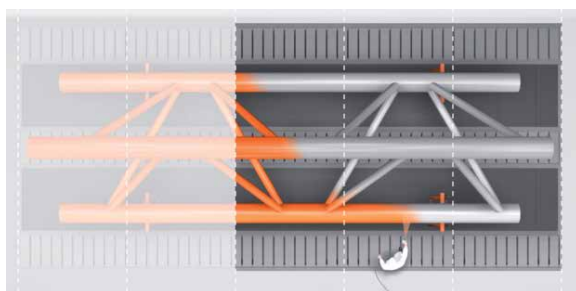
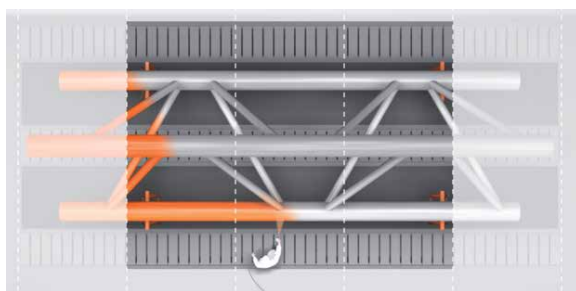
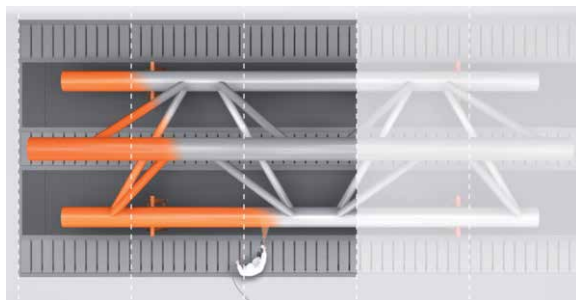

The automatic operator detection system enables sectional control of the fresh air supply and air extraction. Hence significant energy and operating costs savings are possible.



Find more information about our paint spraying systems on our website.

CLEANING BOOTHS

A high quality, durable coating requires a work piece surface that is free from greases and other impurities. This precondition can be achieved with our high-pressure cleaning booths, delivered either as stationary or in telescopic design. The degreasing or cleaning and the following rinsing processes can be performed with only

one cleaning agent, while maintaining consistently good results.

For saving process water and cleaning chemicals and consequently operating costs we recommend the use of an additional process water treatment unit.



Find more information about our cleaning booths on our website.



Telescopic cleaning booth in stainless steel version



Cleaning booth for utility vehicles

Advantages and characteristics of our cleaning booths at a glance:

- provides for optimum precondition for the blasting and coating process
- degreasing and rinsing process possible with one agent only
- high process safety
- closed process water circuit
- use of process water treatment system
- low operating and maintenance costs
- telescopic design possible
- in conformity with Water Resources Act
- design with crane slot for simple overhead handling
- large saving potential regarding used cleaning agent
- conservation of natural resources
- environment-friendly and cost-effective cleaning



Process water treatment system for a cleaning booth

CONVEYING

Our blastrooms, cleaning booths and paint spraying booths are regularly equipped with conveying systems for work pieces or operator lifting systems. These are integrated individually in the premises and process workflows.

Using our lifting platforms the operators are brought into an optimum working position to the work piece. All types of lifting platforms can be provided in special wear resistant design for use in blastrooms or equipped with ex-proof drives for use in paint spraying booths. They dispose of drives that are outside the working area and hence well protected.

In order to guarantee an optimized transport of the customer's work pieces we also offer conveyor technique in the overall project that is adapted to the respective requirements. This includes manual overhead rail systems, power and free conveyors, roller conveyor systems or floor-guided conveyor systems like rail trolleys.



LIFTING PLATFORMS



Swivelling lifting platform in a blastroom

The surface treatment of large and very large work pieces requires optimum accessibility from all angles. It is the best way to obtain first-class and consistent results.

Because of the high quality, robust and flexible design of our standard and special lifting platforms for surface treatment plants, you will secure decisive advantages regarding your production processes.

For many years our lifting platforms have been in long-term use in tough working conditions e.g. in blastrooms, washing, sanding or paint spraying booths. Our lifting platforms feature special low-wear construction when used in blastrooms or an explosion-proof design for use in hazardous areas like paint-spraying booths (equipment options see page 23).

Our program comprises the following types of lifting platforms:

- sidewall scissors-type lifting platforms
- sidewall swivelling lifting platforms
- bridge crane telescopic lifting platforms
- mobile lifting platforms
- various special solutions



Sidewall scissors-type lifting platforms in a paint spraying booth for trams

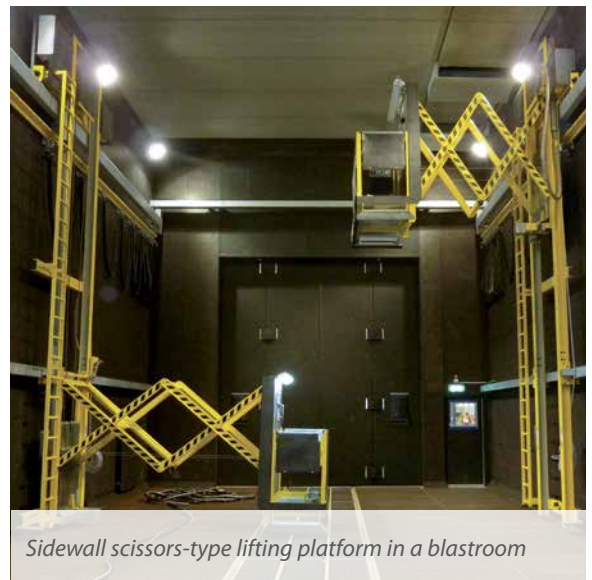

Sidewall scissors-type lifting platform in a blastroom

Equipment variants and options for swivelling and scissors-type lifting platforms

Our lifting platforms are available with many optional items. Among other things, this includes:

- sensing edges to avoid collision damage
- twin running wheels for passing over door rails (e.g. partition doors in booths)
- storage trays (e.g. for tools or other items)
- adjustable guardrail in standard or special design
- devices for power tool dust extraction
- sockets for electric or pneumatic supply for tools or application technique
- pneumatic drives
- illumination of platform cage
- air inlet pressure adjuster



Find more information about our lifting platforms on our website.

Side wall swivelling lifting platforms

Technical Data (type S28)	from mm	to mm
A: Ceiling height	5,200	8,700
B: Retracted platform	1,360	
C: Extended platform	2,860	
D: Access height at ground	400	
E: Platform floor max. height above ground ¹⁾	2,900	6,400
F: Max. height of workpiece	2,650	6,150
Load capacity	250 kg	
Swivelling angle	0 – 90° (6 x 15° increments)	
Cage dimensions	2,150 x 825	

¹⁾ Special solutions are possible up to 8.0 m

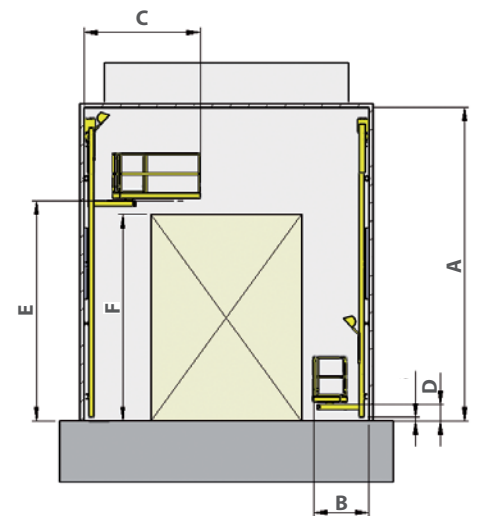

Sidewall scissors-type lifting platforms

Technical Data	HS40xx from mm	HS50xx to mm
A: Ceiling height	5,200	9,250
B: Retracted platform	1,365	
C: Extended platform ¹⁾	4,015	5,000
D: Access height at ground	400	
E: Platform floor max. height above ground ²⁾	2,900	6,400
F: Max. height of workpiece	2,570	6,070
Load capacity	250 kg	150 kg
Cage dimensions	1,260 x 775 (550)	

¹⁾ Special solutions are possible up to 6.0 m, ²⁾ Special solutions are possible up to 8.0 m

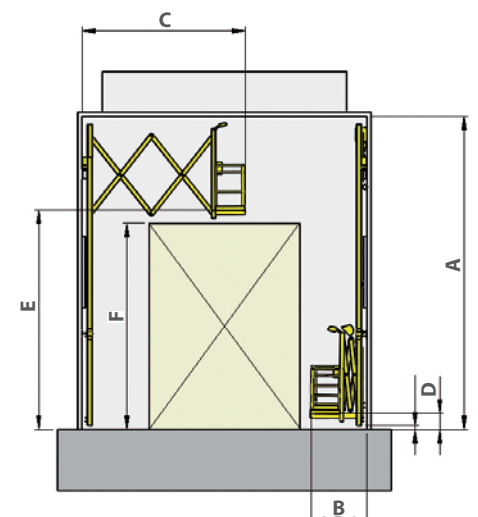

CONVEYING SYSTEMS



Work piece transport device connected to the floor-mounted chain conveyor in a paint spraying booth



Two-part rail-bound trolley for manual work piece transport

Conveying technique for the process-optimized transport of work pieces

Beside lifting technique for your personnel (lifting platforms) we manufacture and integrate conveying systems for the transport of work pieces within the total plant concept. As for the design of the equipment we use proven components thus creating an individual concept meeting your work piece handling requirements.



Electrically driven rail-bound trolley with lifting table



Find more information about our conveying systems on our website.

Our solutions include:

- manually or electrically operated rail-bound trolleys (optionally incl. lifting table)
- Power & Free Conveyors
- manual overhead conveyors
- electric monorail conveyors
- electric chain hoists



Blastroom with chain hoist

CORROSION PROTECTION

Our works in Mühlau have a wide range of machinery on a production area of more than 4,500 m².

With two blastrooms, three turbine wheel blast machines and several open-space paint spraying systems we perform blasting and coating works for customers.

Here we have focused on the treatment of work pieces for the following sectors:

- steel construction (steel hall construction, bridge construction, architectural steel construction)
- vehicle manufacturing
- pipeline construction
- container construction
- apparatus engineering
- electrical engineering and power plant construction

If you require a permanent and high-quality corrosion protection coating or fireproof coating you have found the right partner in us. We annually treat more than 6,000 tons of steel with a total coating surface of approx. 130,000 m².

By means of our 6 bridge cranes we are able to lift and transport work pieces with a single weight of up to 16 t. For reasons of a flexible logistic, steel constructions can be stored temporarily on our open-air storage area (80 x 20 m/L x W) being operated by a gantry crane.

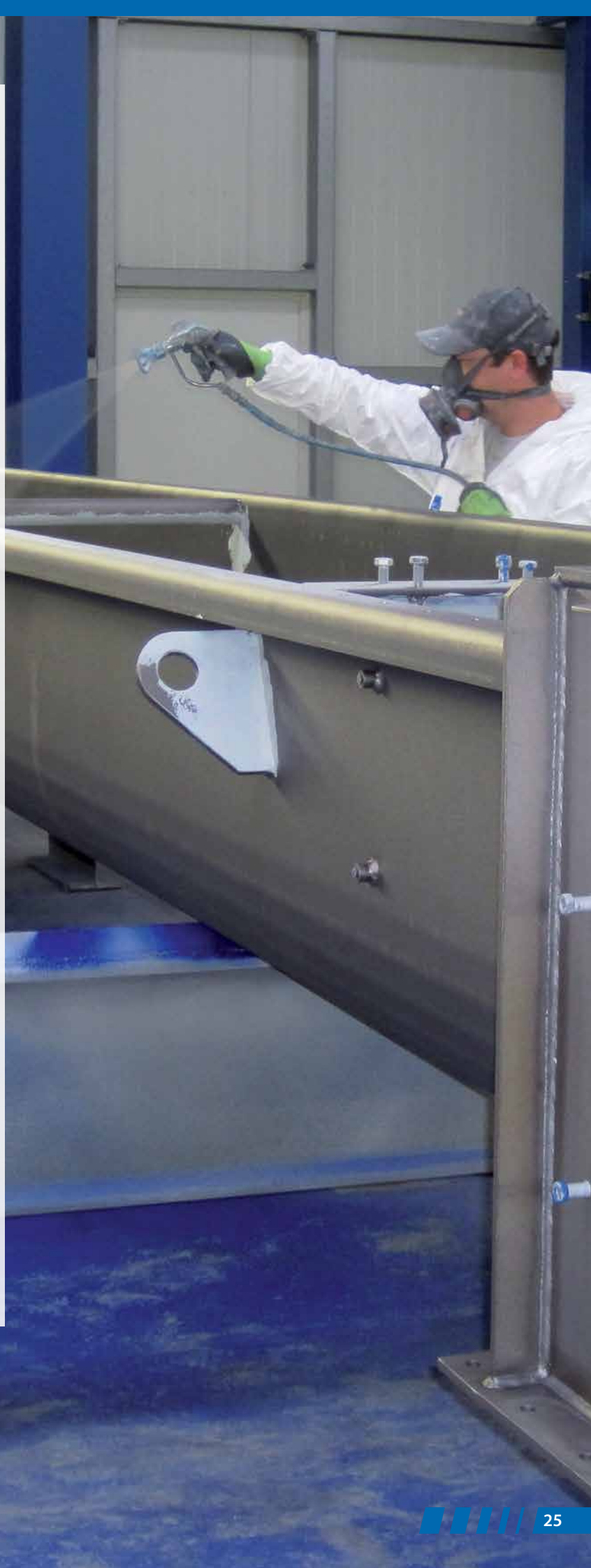

CONTRACT BLASTING SERVICES



Depending on the task different blast media can be used in our blastroom.



Blasted work pieces that are prepared for the transport

Service description

As a preparation for the following coating process the work pieces are blasted in one of our blastrooms or turbine wheel blast systems.



Stainless steel tank blasted with glass beads prior to its coating

Contract blasting for many types of application

For decades we are at our customer's disposal with different blasting systems for the treatment of surfaces and have gained a wealth of experience within this time. We work on your project reliably, experienced and economically.

Contact us, if you are looking for a specialist company for contract blasting services. Work pieces can be

- cleaned
- deburred
- derusted
- descaled
- decoated

We also perform blasting services for you!

We offer:

- comprehensive consulting
- contract blasting services of the highest quality
- quick and professional work based on many years of experience

CONTRACT COATING SERVICES



Profiles and constructions of steel halls are one of our core areas.



Our factory in Mühlau has large storage and production areas.

Service description

In the vehicle construction and steel hall construction industry as well as other industrial and commercial areas of application the highest quality requirements regarding corrosion protection characteristics of the used materials apply. In other cases special requirements regarding fire resistance of surfaces apply.

Since our employees constantly acquire further qualifications our products are current state of the art and we are always able to fulfil the different complex requirements of customers.

As a customer for coating services you will receive

- comprehensive consulting
- quick and professional work based on many years of experience
- corrosion protection coatings
- fire-proof coatings
- coating service on site

Quality assurance at the highest level

In order to be able to proof the performance of corrosion protection respectively coating services according to the regulations, we carry out our services in compliance with the directives of DIN EN 1090 and provide the necessary measuring, control and documentation devices.

Application technique

For the performance of coating works we use different efficient application techniques like e. g. airless pumps, air-assisted airless technique (Airmix), electrostatic systems and a paint spraying technique with a low overspray.

EXTENSIVE RANGE OF SERVICES

Long-term and mutually successful business relationships are our top priority. Many of our customers have developed successfully together with us during the past years and again placed their trust in us as supplier of airblasting, paint spraying and conveyor technique.

For many of our customers we have become their system supplier thanks to our professional order processing and high quality of our products and services. We have many customers that are market leaders in their industries and that rely on us regarding surface treatment technology with their subsidiaries and at different locations.

We provide assistance to our customers from the first contact and customized planning and the complete order processing to the supply of wear parts and maintenance works from one source. Our qualified personnel are available at any time.

Our services at a glance:

- customized planning and consulting
- support during regulatory authorization procedures
- mechanical and electrical installation or supervision of installation
- instruction and training of your personnel
- modernization, modification and reallocation of your system
- maintenance contracts
- supply of spare and wear parts
- 24h Service-Hotline
+49(0)2572 1537-3

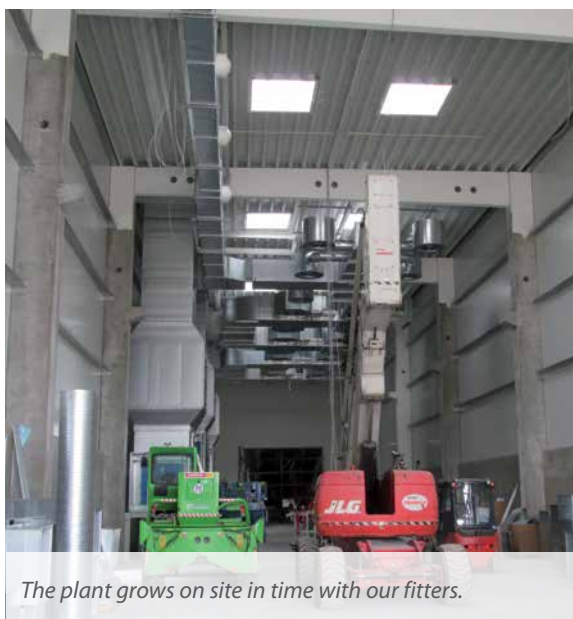

The plant grows on site in time with our fitters.

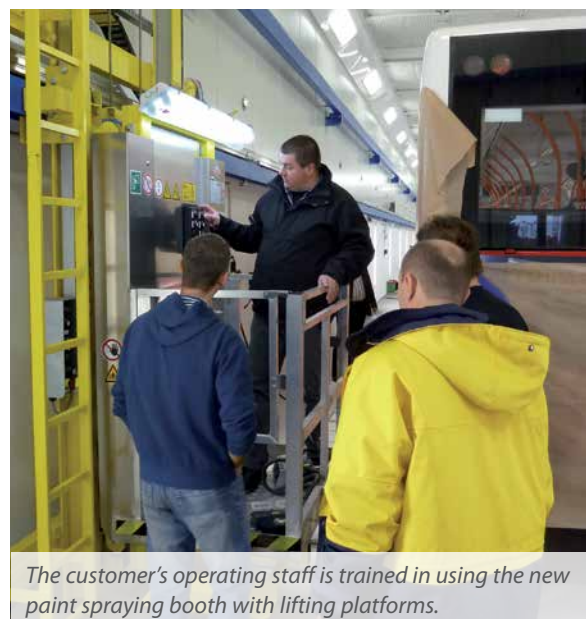

The customer's operating staff is trained in using the new paint spraying booth with lifting platforms.

MAINTENANCE AND REPAIR



Our service team supports you regarding maintenance, repair and plant modernization.

We invest much passion and professionalism in the planning, design and assembly of your surface treatment plant – however it is a high tech product which after purchase is subject to a certain regular care in order to work smoothly on a sustainable basis.

During commissioning we provide maintenance records individually adapted to your surface treatment plant that exactly define the essential maintenance works to do at your plant and their regular cycles.

If there are nevertheless any problems with your plant, we offer a technical emergency service that can be reached by phone (+49(0)2572 1537-3). The error indication acceptance is provided 24 hours a day, also at weekends.

The following working day one of our qualified service representatives will get in touch with you to directly start with service at your plant.

In addition you have the possibility to conclude a maintenance contract for your surface treatment plant. Based on this contract our specialists regularly take care of the inspection of your plant and take measures if necessary. In this way you increase the plant availability and protect it from unpleasant surprises.

SPARE AND WEAR PARTS



Long-lasting boron carbide blast nozzles and protective cones for low-wear blasting



We provide spare and wear parts for pressure and suction blast equipment.

Protective equipment consisting of: Blasting operative's protective suit, gloves and protective helmet



Further spare and wear parts:

- nozzle holders
- silencers
- compressed air filters
- couplings
- sealings
- hose clamps
- diaphragm valves
- suction blast heads
- gas pressure springs
- dead man's switch
- compressed air hoses
- fresh air and supply air filters
- overspray filters

The right spare and wear parts are an essential prerequisite for smooth functioning and for a professional and preventive maintenance of your plant.

Beside wear parts for our plants we also carry wear parts from plants of external providers.

If you are not a customer of our services department up to now, just contact us and convince yourself of our first-class service!

Request your required wear parts!

QUALIFICATION: CONTINUOUS TRAINING AND FURTHER EDUCATION

Every company is only as good as its employees. This is an old wisdom we follow all times. Our dynamic development faces us with the challenge to place the satisfaction of our customers into the centre of all our activities – now and in future. We welcome this challenge and therefore we place particular value on the advanced training and continuing education of our employees. Especially young people are offered the chance to learn one of our growing numbers of training professions from scratch thus enabling a start into a secure future.

In our works we provide vocational training as mechatronics engineers, technical product designer, industrial clerk, industrial painters. Our aim is the offer of a contract of employment after successful apprenticeship and the start of a career in a dynamically growing, owner-managed company.



Since our foundation we furthermore cooperate with the engineering faculty of the advanced technical college in Münster. This provides a lively exchange regarding new and further developments of our plant components and equipment.

In this way we are also in contact with graduates of the technical college thus increasing our degree of popularity in order to enthuse junior employees with **SLF** as their future employer. The modern workplace equipment is another pillar on which our competence is built.

Fachhochschule
Münster University of
Applied Sciences



RANGE OF PRODUCTS AND SERVICES

Blasting systems

- blastrooms
- pressure and suction blast cabinets
- media blast robot "ReCo-Blaster®"
- manual blast cabinets

Paint spraying systems

- wet paint spraying systems
- combined paint spraying and drying booths
- open-space paint spraying systems
- high-pressure cleaning systems
- powder coating systems
- paint dryers and powder enamelling furnaces

Conveyor technique

- overhead conveying systems
- roller conveyor systems
- floor-guided transport systems

Lifting platforms

- sidewall scissors-type and swivelling lifting platforms
- crane bridge guided vertical telescopic lifting platform
- mobile lifting platforms

Service and spare parts

Corrosion protection (Mühlau)

- contract blasting services
- contract coating services



SLF Oberflächentechnik GmbH

Factory Emsdetten (Head Office)

Gutenbergstr. 10
D-48282 Emsdetten

Phone: +49(0)2572 1537-0
Fax: +49(0)2572 1537-169

info@slf.eu
www.slf.eu

Factory Mühlau

Waldstr. 8
D-09241 Mühlau

Phone: +49(0)3722 6071-0
Fax: +49(0)3722 6071-20

post@slf.eu
www.slf.eu



SLF on Youtube: www.youtube.com/slfsurfacetechnology